



Product Catalog
2024-2025



About NuBoard

NuBoard™
PACKAGING

NuBoard is a nationwide packaging distributor providing a wide variety of retail bag types, e-commerce adhesive mailers & additional packaging products since 2000. We offer very competitive pricing, eco-friendly materials and excellent service. NuBoard is committed to offering packaging from sustainable materials.

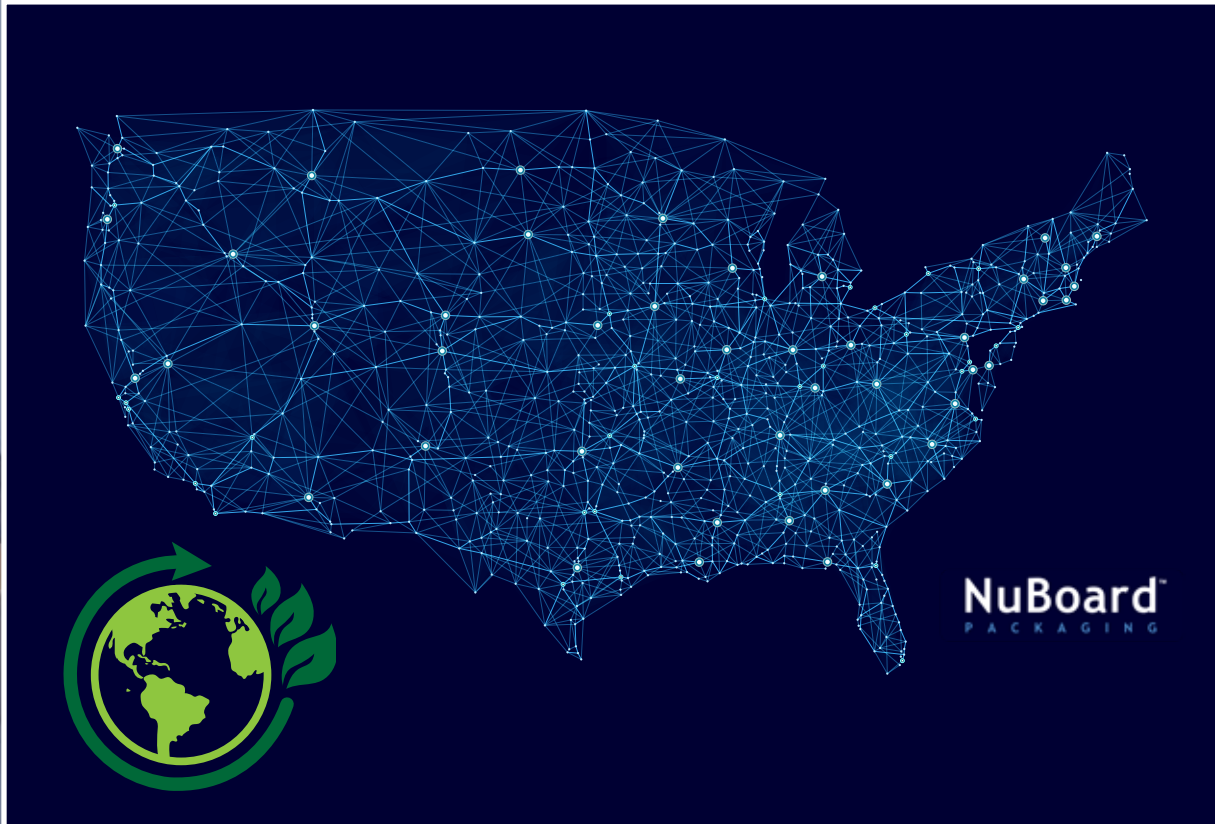

Benefits of NuBoard

- Very Competitive Pricing
- 20+ Years in Business
- Domestic USA & Import Production
- Eco-Friendly
- Wide Variety of Retail Bag Types
- E-commerce Mailer Bags & Packaging
- Nationwide Clients
- Printed or Unprinted bags
- 4 Weeks Lead Time Domestic
- 14 Weeks Lead Time Import
- Excellent Client Service
- Warehousing Available

Index

| | |
|------------------------------------------|----|
| About NuBoard..... | 2 |
| Kraft Paper Shopper Bags | 3 |
| Biodegradable Bags / LDPE Poly Bags..... | 4 |
| E-Commerce Mailer Bags | 5 |
| Euro Tote Shopper Bags..... | 6 |
| Reusable Totes Non-Woven & Laminated ... | 7 |
| Flat Merchandise Bags / SOS..... | 8 |
| Printed Boxes..... | 9 |
| Food Service Bags..... | 10 |
| Stadium Security Clear Policy Bags..... | 11 |
| Healthcare Bags..... | 12 |
| Promotional Products..... | 13 |
| NuBoard Partners | 14 |

Miami
T 305.781.6620
fallegro@nuboardmedia.com

nuboardpackaging.com
f X in y

Naples
T 678.637.4949
jallegro@nuboardmedia.com



Info

- Domestic USA & Import Production
- Wide Variety of Sizes
- Min 95% Post Consumer Paper (Natural)
- Min 40% Post Consumer Paper (White)
- FSC Certified
- 100% Recyclable Paper
- Plain Natural Kraft
- Plain White Kraft
- Twisted Handle
- 4 Weeks Lead Time Domestic
- 14 Weeks Lead Time Import

Colors

Hot Stamping - Stock Foil

Matte Foils

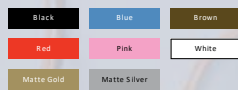

Metallic Foils



Approximate color swatches provided for reference only. Non-stock foils and inks available per quotation.

Flexographic Printing - Stock Ink



Approximate color swatches provided for reference only. May be subject to special ink charges and ink policies.

Sizes

Standard Bag Sizes Available:

- 5 1/2" x 3 1/4" x 8 3/8"
- 5 1/2" x 3 1/4" x 13"
- 8" x 5" x 10 1/4"
- 10" x 5" x 13"
- 10" x 7" x 12"
- 13" x 7" x 13"
- 13" x 7" x 17"
- 14 1/2" x 9" x 16 1/4"
- 16" x 6" x 12"
- 18" x 7" x 18"

Biodegradable Bags / LDPE Poly Bags

NuBoard™
PACKAGING

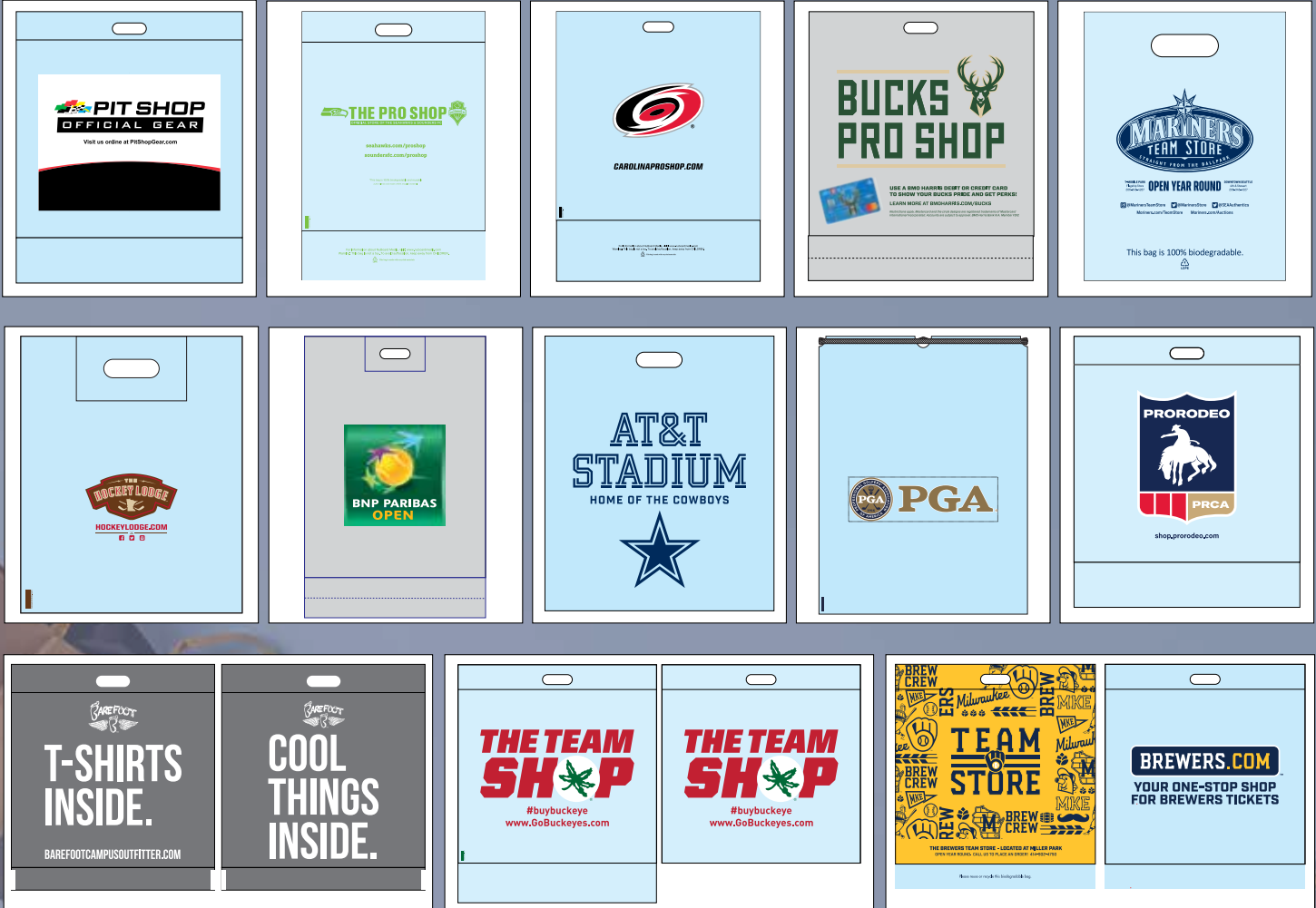

Info

- Domestic USA & Import Production
- Wide Variety of Sizes
- Biodegradable Film bags
- 100% Compostable bags
- Plant-based Sugarcane bags
- 40% Post Consumer bags
- Unprinted or Printed bags
- Drawstring bags
- Frosted bags
- T-Shirt bags
- Patch, Flush & Foldover Die-Cut bags
- LDPE & HDPE Poly bags
- 4 Weeks Lead Time Domestic
- 14 Weeks Lead Time Import

Sizes

- 9" x 12"
- 12" x 15"
- 14" x 18"
- 15" x 18" x 4"
- 15" x 20"
- 18" x 18" x 6"
- 18" x 21"
- 20" x 20 ½" x 6"
- More Sizes Available
- Custom Sizes

Miami
T 305.781.6620
fallegro@nuboardmedia.com

nuboardpackaging.com
f X in v

Naples
T 678.637.4949
jallegro@nuboardmedia.com

E-Commerce Mailer Bags

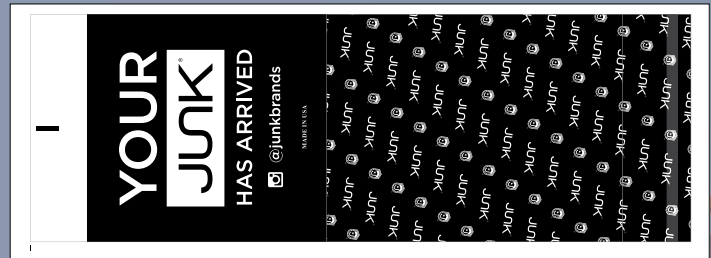
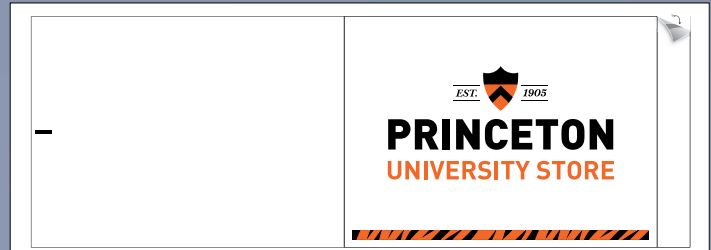
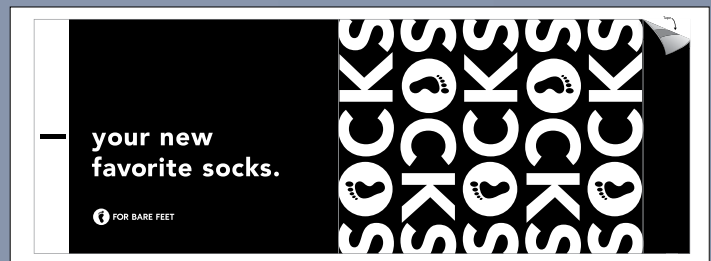

Eco Paper Mailers

- Made in USA
- 100% Recyclable
- Contains Recycled Fibers
- Wide variety of sizes
- Biodegradable & Compostable
- Printed with water-based ink
- Resealable lip available for returns



Poly LDPE & Bio Mailers

- Domestic USA & Import Production
- 1.75 Mil / 2 Mil / 2.5 Mil Gauges
- Standard LPPE Film
- Blue Earth BIO Film (75% Recycled Content 25% Post-Consumer)
- Resealable Tape & Permanent Adhesive
- 8-Color & 4-Color Process Printing
- "Skip" Glue Closure & Perforations
- 4 Weeks Lead Time Domestic
- 14 Weeks Lead Time Import

Sizes

- Paper Adhesive Eco Mailers from 5" x 10" to 16" x 1 1/4" x 22"
- Poly Adhesive Mailers from 6" x 9" + 2" Lip to 9" x 24" + 2" Lip
- More Sizes Available
- Custom Sizes

Euro Tote Shopper Bags

NuBoard™
PACKAGING



Info

- Import
- High Quality Paper Shopper Bags
- GSM 100 - 200 Paper
- 40% Post-Consumer Paper Available
- Wide Variety of Bag Types & Sizes
- Rope & Ribbon Handle
- Variety of handle colors
- Cardboard bottom
- Digital Proofs and Hard Copy Proofs
- Min 3,000 qty
- Imported 14 weeks Lead Time

Sizes

- From 8" x 5" x 10" to 20" x 6" x 20"
- 8" x 5" x 10"
- 10" x 5" x 13"
- 16" x 6" x 12"
- 20" x 6" x 20"
- More Sizes Available
- Custom Sizes

Miami
T 305.781.6620
fallegro@nuboardmedia.com

nuboardpackaging.com
f X in v

Naples
T 678.637.4949
jallegro@nuboardmedia.com



Info

- High Quality Shopper Bags
- Wide Variety of Sizes
- Custom sizes and Standard sizes
- 26" Handle
- Digital Proofs
- Variety of High Quality PP Non-Woven Material
- Min 3,000 qty
- 14 Weeks Lead Time import

Sizes

- From 10" x 5" x 13" to 20" x 6" x 20"
- 8" x 5" x 10"
- 10" x 5" x 13"
- 16" x 6" x 12"
- 20" x 6" x 20"
- More Sizes Available
- Custom Sizes



Info

- Made in USA
- Wide Variety of Sizes
- 100% Recyclable Paper
- 100% Print Coverage
- Unprinted available
- Natural
- White
- 10 Standard Colors
- Customized Colors
- Min 1,000 qty.
- 4 Weeks Lead Time

Colors

Stock Merchandise Colors

| | |
|------------------------|--------------------|
| Black (BK) | Purple (PR) |
| Cream (CR)* | Red (RD) |
| Forest (FG) * Green | Sky (SK) Blue |
| Lime (LG) Green | Sunbrite (SB) |
| Petal (PP) Pink | Wild (WR)* Rose |

*Tinted Paper

Sizes

- From 5" x 7 1/2" to 16" x 3 3/4" x 24"
- 9 Standard Flat Merchandise Paper Bag Sizes
- 5" x 7 1/2"
- 6 1/4" x 9 1/4"
- 7 1/2" x 10 1/2"
- 8 1/2" x 11"
- 10" x 13"
- 12" x 15"
- 14 3/4" x 18"
- More Sizes Available
- Custom Sizes

Miami
T 305.781.6620
fallegro@nuboardmedia.com

nuboardpackaging.com



Naples
T 678.637.4949
jallegro@nuboardmedia.com

Printed Boxes

NuBoard™
PACKAGING

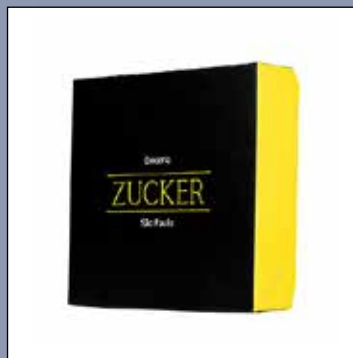
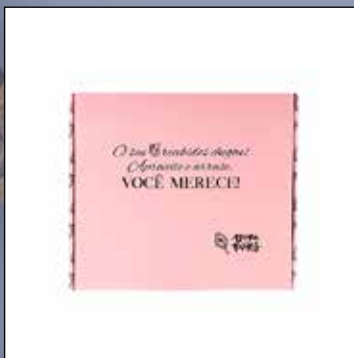
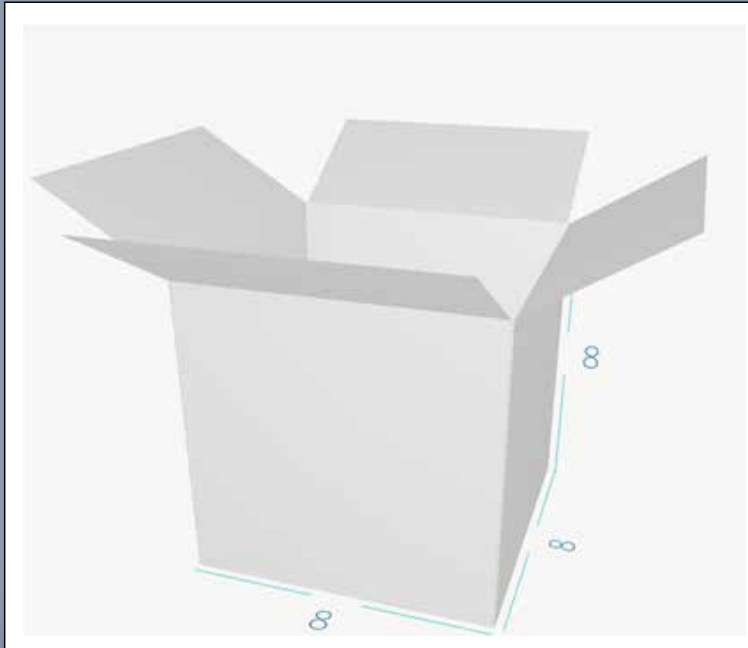

Info

- Import only
- Wide Variety of Sizes
- Custom sizes and Standard sizes
- Digital Proofs
- Min 1,000 qty
- 14 Weeks Lead Time import

Sizes

- Example standard sizes
- 4" x 4" x 4"
- 6" x 6" x 7"
- 7" x 7" x 3"
- 8" x 8" x 8"
- 8" x 8" x 20"
- 11" x 8" x 7"
- More Sizes available

Miami
T 305.781.6620
fallegro@nuboardmedia.com

nuboardpackaging.com
f X in y

Naples
T 678.637.4949
jallegro@nuboardmedia.com



QUICK HANDLE BAG PRODUCT & SIZE GUIDE

While used widely in all market segments, these sizes are also top sellers in foodservice carryout.



Info

- Domestic USA & Import Production
- Wide Variety of Sizes
- 100% recyclable Paper
- Min 95% Post Consumer Paper (Natural)
- Min 40% Post Consumer Paper (White)
- FSC Certified
- Plain Natural Kraft
- Plain White Kraft
- Twisted Handle
- No Handle (1/16 Barrel)
- 4 Weeks Lead Time Domestic
- 14 Weeks Lead Time Import

Bag Types

- Food Take-Out Bags
- Bread and Bakery Bags
- Concession Bags
- Gourmet Bags
- Grease Resistant
- Bags Liquor & Wine Bags
- Popcorn Bags
- French Fries Bags
- And more bag types available

Sizes

- From 5 1/2" x 3 1/4" x 8 3/8"
- to 18" x 7" x 18"
- 14 Standard Food Service Bag Sizes
- 8" x 5" x 10"
- 10" x 5" x 13"
- 16" x 6" x 12"
- 18" x 7" x 18"
- More Sizes Available
- Custom Sizes

Stadium Security Clear Policy Bags

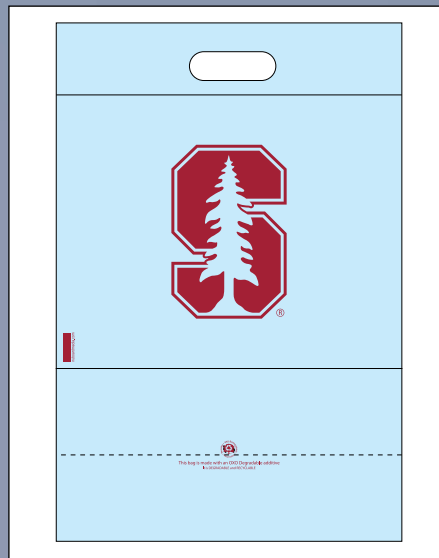
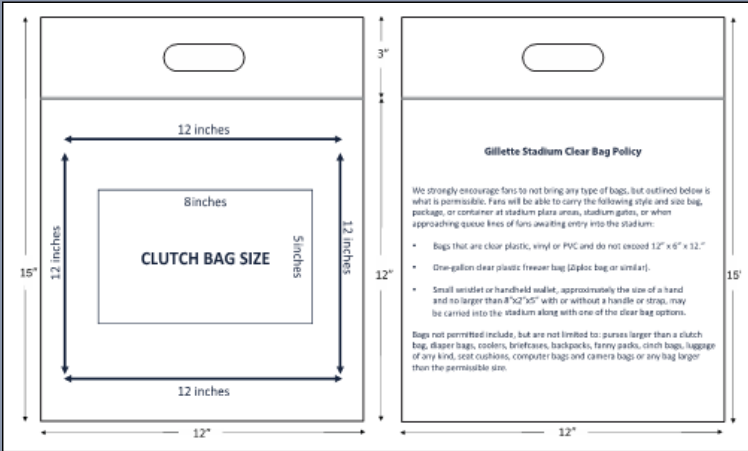

Info

- Stadium-approved Clear Bags
- Wide Variety of Sizes
- Channel Lock
- PVC Clear Totes
- Digital Proofs
- Printed or Plain
- Min 3,000 qty
- Made in USA

Sizes

- As Mandated by Stadium / Venue
- Wide Variety of Sizes
- 12" x 12" x 6" PVC Clear Tote
- 20" Handle PVC Tote
- More Sizes Available
- Custom Sizes

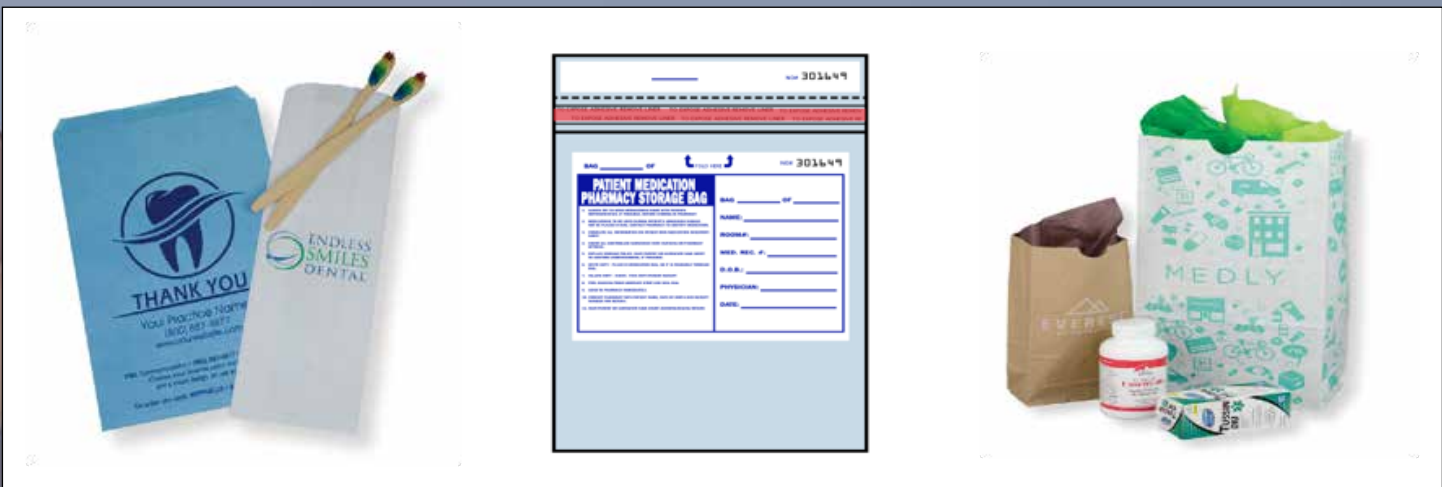

Info

- Made in USA
- Wide Variety of Sizes
- Patient Belongings Bags
- Biohazard Waste Bags
- Specimen Transport Bags
- Patient Valuables Bags
- Printable with writable backing
- Sundry /Gift Shop Bags
- Paper Pharmacy Bags
- 4-Weeks lead times
- 100% Recyclable Film
- Various Tamper Evident Closures
- Permanent Adhesive Closures
- Channel Lock sealable

Sizes

- 20" x 21" x 6" - Patient bags
- 40" x 46" - Biohazard bags
- 8" x 10" - Specimen bags
- 10" x 13" + 3" - Valuables bags
- Paper Pharmacy Bags
 - 3 ½" x 2" x 10 ¼"
 - 5" x 2 ½" x 10 ¼"
 - 5" x 2" x 12" – Stock bags
- More Sizes Available
- Custom Sizes

Promotional Products

NuBoard™
PACKAGING

NuBoard offers 1000's of choices of high-quality promotional items for sponsor brands, agencies & rights-holders. Due to our stadium reach and high volume of distribution, we offer very competitive pricing.



Miami
T 305.781.6620
fallegro@nuboardmedia.com

nuboardpackaging.com
f X in y

Naples
T 678.637.4949
jallegro@nuboardmedia.com

NuBoard Partners



NuBoard has partnered with 300+ world-class brands as a retail packaging supplier & an in-stadium activations provider. We are thankful for our growing list of partnerships since the year 2000.



Miami
 T 305.781.6620
 falledgro@nuboardmedia.com

nuboardpackaging.com
 f X in v

Naples
 T 678.637.4949
 jalledgro@nuboardmedia.com